

THE PROPERTY OF THE DRAWING IS ESTABLISHED BY LAW. IT IS FORBIDDEN TO PRODUCE OR SHOW IT TO THIRD PART. WITHOUT A WRITTEN AGREEMENT.

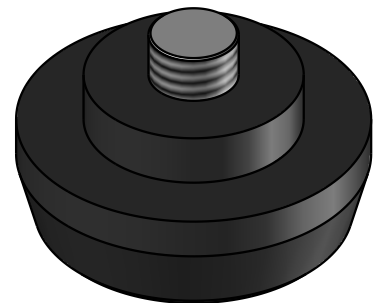
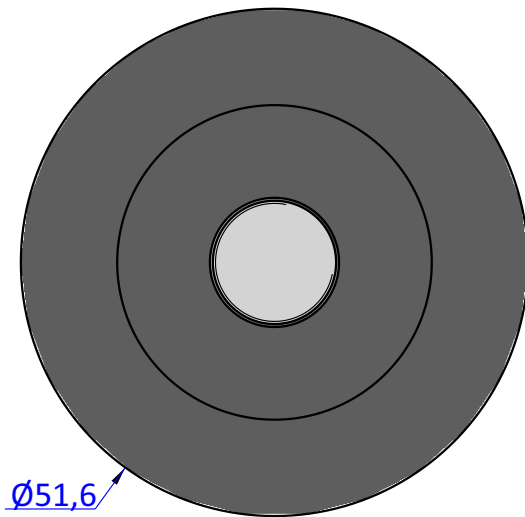
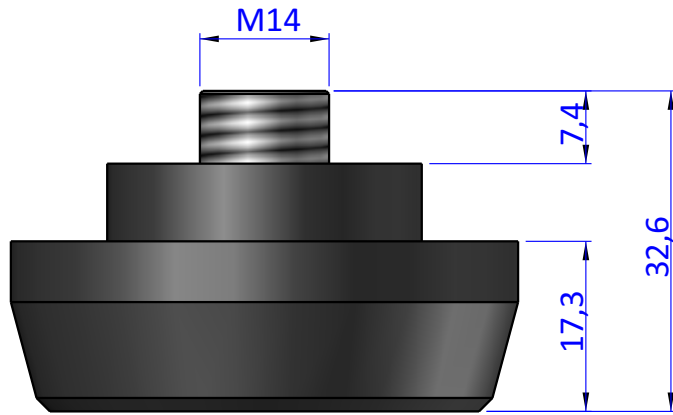

DESIGNED FROM FPS Automation		REVIEW A
DATE 06/10/2020	WEIGHT 0,012kg	
CODE CA.09.16.008		

Format A4
UNI 936-76

GENERAL TOLERANCE UNI - ISO 2768 CLASSE f

DESCRIPTION CA.09.16.008
